



INTAKE SYSTEMS FOR VEHICLES LISTED ARE 50 STATE LEGAL. SEE KNFILTERS.COM FOR CARB STATUS ON EACH PART FOR A SPECIFIC VEHICLE.

INSTALLATION INSTRUCTIONS

57-1519
JEEP
1991-95 Cherokee
L6-4.0L

NOTE: This kit was not designed to fit vehicles with a body lift.

TOOLS NEEDED:

- Flat blade screwdriver
- 13mm wrench
- 7/16" wrench

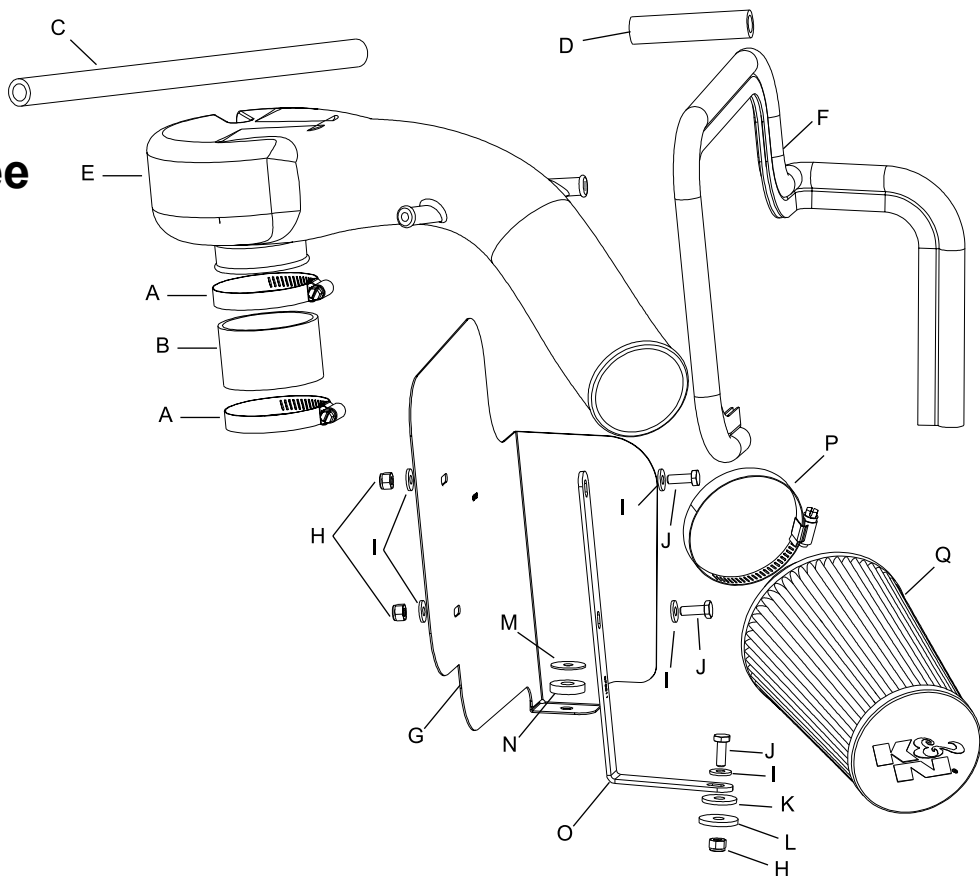

PARTS LIST:			
	Description	Qty.	Part #
A	Hose Clamp #40	2	08554
B	Hose; 2-5/8"ID x 1.75"L	1	08108
C	Hose; 1/2"ID x 15-3/4"L	1	08414
D	Hose; 1/2"ID x 3.5"L	1	087028
E	Intake Tube	1	087027A
F	Edge Trim 39"L	1	102496
G	Heat Shield	1	07452
H	Nut, 1/4-20 Nylock	3	07517
I	Washer, 1/4"ID x 5/8"OD	5	08275
J	Bolt; 1/4-20 x 3/4"	3	08386
K	Washer; 1" x .300" x .063"	1	21685
L	Washer, 1"D x 1/4"	1	08160
M	Washer; 5/16 x 1.25"	1	08130
N	Washer; 1"OD x .37"ID	1	08281
O	Bracket	1	070011
P	Hose Clamp #48	1	08061
Q	Air Filter	1	RU-4690

NOTE: FAILURE TO FOLLOW INSTALLATION INSTRUCTIONS AND NOT USING THE PROVIDED HARDWARE MAY DAMAGE THE INTAKE TUBE, THROTTLE BODY AND ENGINE.

TO START:

1. Turn off the ignition and disconnect the negative battery cable.
NOTE: Disconnecting the negative battery cable erases pre-programmed electronic memories. Write down all memory settings before disconnecting the negative battery cable. Some radios will require an anti-theft code to be entered after the battery is reconnected. The anti-theft code is typically supplied with your owner's manual. In the event your vehicles' anti-theft code cannot be recovered, contact an authorized dealership to obtain your vehicles anti-theft code.



2. Remove the crankcase vent line from the valve cover.



3. Remove the EVAP canister vent line from the air cleaner lid.



4. Loosen the hose clamp at the throttle body and unclamp the airbox lid then remove the upper intake assembly as shown.



5. Loosen and remove the two bolts and one hex nut that secure the lower air cleaner assembly.



6. Remove the lower air cleaner assembly as shown
NOTE: K&N Engineering, Inc., recommends that customers do not discard factory air intake.

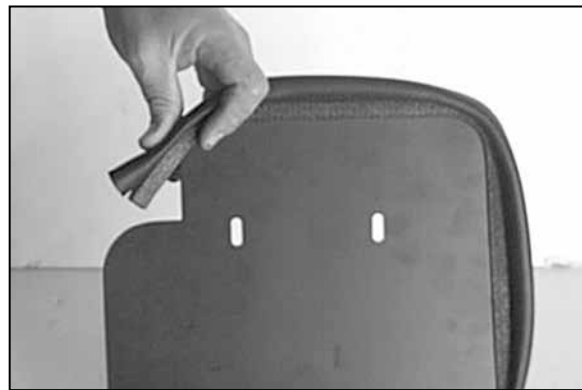

7. Install the trim seal onto the heat shield. Trim excess if needed



8. Using the provided hardware, secure the "L" bracket to the heat shield as shown.

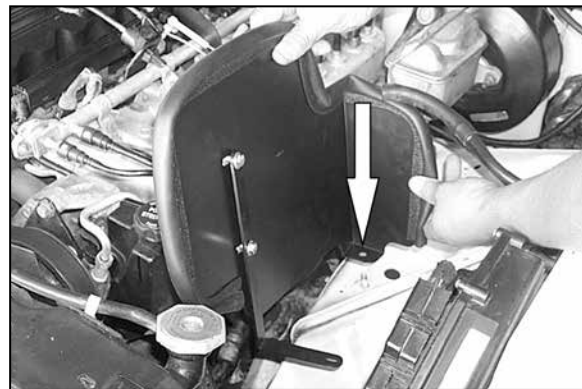

9. Install the heat shield assembly into the vehicle lining up the factory stud with the tab on the heat shield.

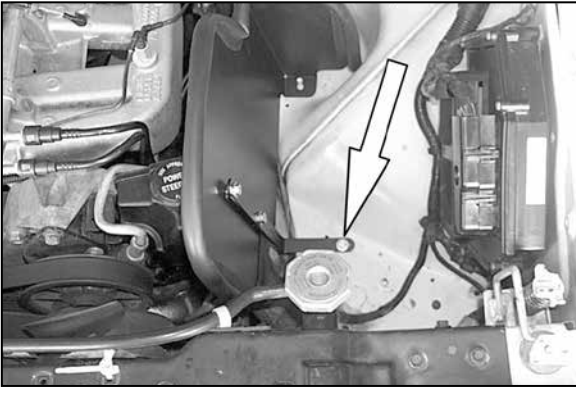

10. Using the provided hardware, secure the "L" bracket to the inner fender as shown.

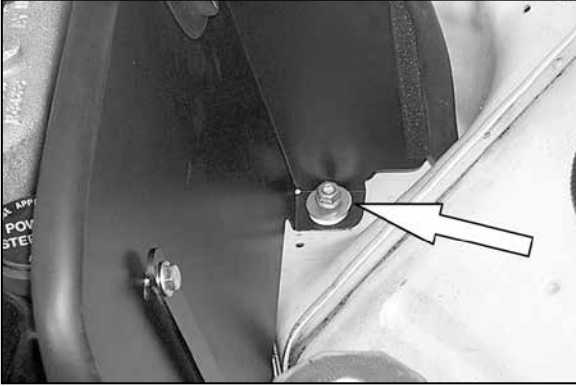

11. Using the provided washers and the hex nut removed in step 5, secure the heat shield assembly to the existing stud as shown.



12. Install the silicone hose and the hose clamps onto the throttle body as shown



13. Install the K&N® intake tube onto the throttle body and tighten the hose clamp.

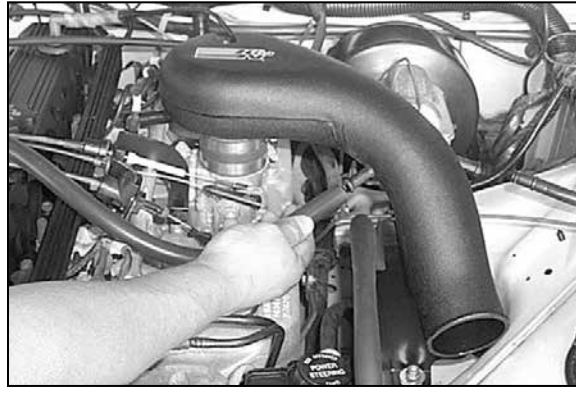

14. Install the provided silicone hose onto the crankcase vent, then install the other end onto the K&N® intake tube

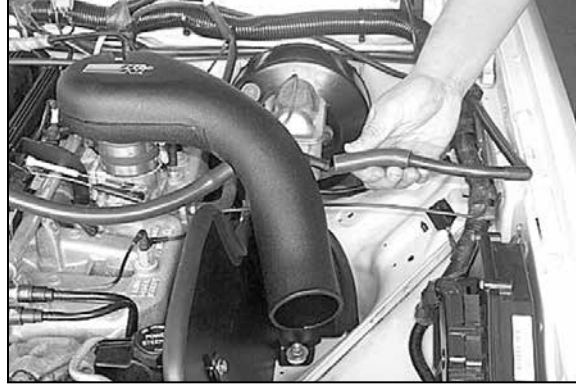

15. Install the provided silicone hose onto the EVAP canister vent line then secure the other end onto the K&N® intake tube.

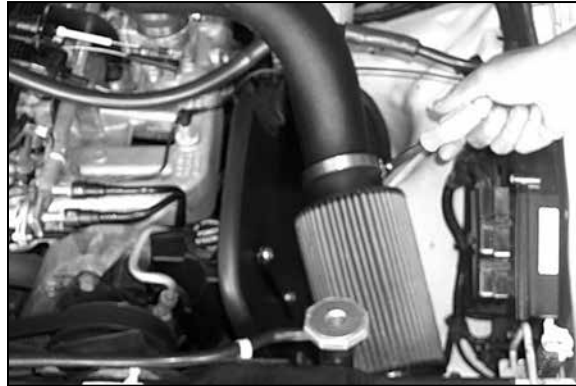

16. Install the K&N® Filtercharger onto the K&N® intake tube as shown.

NOTE: Drycharger® air filter wrap; part # RC-4690DK is available to purchase separately. To learn more about Drycharger® filter wraps or look up color availability please visit <http://www.knfilters.com>®.

17. Reconnect the vehicle's negative battery cable. Double check to make sure everything is tight and properly positioned before starting the vehicle.

18. The C.A.R.B. exemption sticker, (attached), must be visible under the hood so that an emissions inspector can see it when the vehicle is required to be tested for emissions. California requires testing every two years, other states may vary.

19. It will be necessary for all K&N® high flow intake systems to be checked periodically for realignment, clearance and tightening of all connections. Failure to follow the above instructions or proper maintenance may void warranty.

ROAD TESTING:

1. Start the engine with the transmission in neutral or park, and the parking brake engaged. Listen for air leaks or odd noises. For air leaks secure hoses and connections. For odd noises, find cause and repair before proceeding. This kit will function identically to the factory system except for being louder and much more responsive.

2. Test drive the vehicle. Listen for odd noises or rattles and fix as necessary.

3. If road test is fine, you can now enjoy the added power and performance from your kit.

4. K&N Engineering, Inc., requires cleaning the intake system's air filter element every 100,000 miles. When used in dusty or off-road environments, our filters will require cleaning more often. We recommend that you visually inspect your filter once every 25,000 miles to determine if the screen is still visible. When the screen is no longer visible some place on the filter element, it is time to clean it. To clean and re-oil, purchase our filter Recharger® service kit, part number 99-5050 or 99-5000 and follow the easy instructions.

INTAKE SYSTEMS FOR VEHICLES LISTED ARE 50 STATE LEGAL. SEE KNFILTERS.COM FOR CARB STATUS ON EACH PART FOR A SPECIFIC VEHICLE.